

Asymmetrical - Bridge MOSFET Power Module

$$V_{DSS} = 100V$$

$$R_{DSon} = 9m\Omega \text{ typ @ } T_j = 25^\circ C$$

$$I_D = 139A \text{ @ } T_c = 25^\circ C$$

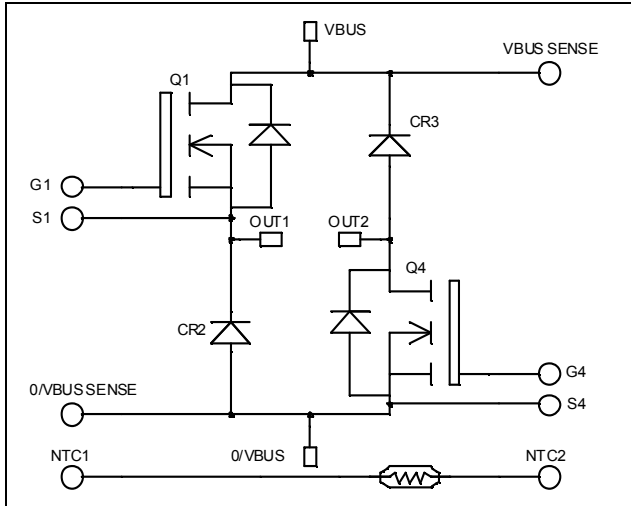

Application

- Welding converters
- Switched Mode Power Supplies
- Switched Reluctance Motor Drives

Features

- Power MOS V[®] MOSFETs
 - Low R_{DSon}
 - Low input and Miller capacitance
 - Low gate charge
 - Avalanche energy rated
 - Very rugged
- Kelvin source for easy drive
- Very low stray inductance
 - Symmetrical design
 - Lead frames for power connections
- Internal thermistor for temperature monitoring
- High level of integration

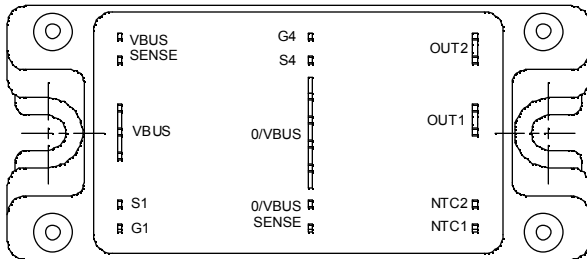

Benefits

- Outstanding performance at high frequency operation
- Direct mounting to heatsink (isolated package)
- Low junction to case thermal resistance
- Solderable terminals both for power and signal for easy PCB mounting
- Low profile
- RoHS Compliant

Absolute maximum ratings

Symbol	Parameter	Max ratings	Unit
V_{DSS}	Drain - Source Breakdown Voltage	100	V
I_D	Continuous Drain Current	$T_c = 25^\circ C$	139
		$T_c = 80^\circ C$	100
I_{DM}	Pulsed Drain current	430	
V_{GS}	Gate - Source Voltage	± 30	V
R_{DSon}	Drain - Source ON Resistance	10	$m\Omega$
P_D	Maximum Power Dissipation	$T_c = 25^\circ C$	390
I_{AR}	Avalanche current (repetitive and non repetitive)	100	A
E_{AR}	Repetitive Avalanche Energy	50	mJ
E_{AS}	Single Pulse Avalanche Energy	3000	

CAUTION: These Devices are sensitive to Electrostatic Discharge. Proper Handling Procedures Should Be Followed. See application note APT0502 on www.microsemi.com

All ratings @ $T_j = 25^\circ\text{C}$ unless otherwise specified

Electrical Characteristics

Symbol	Characteristic	Test Conditions	Min	Typ	Max	Unit
I_{DSS}	Zero Gate Voltage Drain Current	$V_{GS} = 0\text{V}, V_{DS} = 100\text{V}$			100	μA
		$V_{GS} = 0\text{V}, V_{DS} = 80\text{V}$			500	
$R_{DS(on)}$	Drain – Source on Resistance	$V_{GS} = 10\text{V}, I_D = 69.5\text{A}$		9	10	$\text{m}\Omega$
$V_{GS(th)}$	Gate Threshold Voltage	$V_{GS} = V_{DS}, I_D = 2.5\text{mA}$	2		4	V
I_{GSS}	Gate – Source Leakage Current	$V_{GS} = \pm 30\text{V}, V_{DS} = 0\text{V}$			± 100	nA

Dynamic Characteristics

Symbol	Characteristic	Test Conditions	Min	Typ	Max	Unit
C_{iss}	Input Capacitance	$V_{GS} = 0\text{V}$ $V_{DS} = 25\text{V}$ $f = 1\text{MHz}$		9875		pF
C_{oss}	Output Capacitance			3940		
C_{rss}	Reverse Transfer Capacitance			1470		
Q_g	Total gate Charge	$V_{GS} = 10\text{V}$ $V_{Bus} = 50\text{V}$ $I_D = 139\text{A}$		350		nC
Q_{gs}	Gate – Source Charge			60		
Q_{gd}	Gate – Drain Charge			180		
$T_{d(on)}$	Turn-on Delay Time	Inductive switching @ 125°C $V_{GS} = 15\text{V}$ $V_{Bus} = 66\text{V}$ $I_D = 139\text{A}$ $R_G = 5\Omega$		35		ns
T_r	Rise Time			70		
$T_{d(off)}$	Turn-off Delay Time			95		
T_f	Fall Time			125		
E_{on}	Turn-on Switching Energy	Inductive switching @ 25°C $V_{GS} = 15\text{V}, V_{Bus} = 66\text{V}$ $I_D = 139\text{A}, R_G = 5\Omega$		552		μJ
E_{off}	Turn-off Switching Energy			604		
E_{on}	Turn-on Switching Energy	Inductive switching @ 125°C $V_{GS} = 15\text{V}, V_{Bus} = 66\text{V}$ $I_D = 139\text{A}, R_G = 5\Omega$		608		μJ
E_{off}	Turn-off Switching Energy			641		

Diode ratings and characteristics

Symbol	Characteristic	Test Conditions	Min	Typ	Max	Unit
V_{RRM}	Maximum Peak Repetitive Reverse Voltage		200			V
I_{RM}	Maximum Reverse Leakage Current	$V_R = 200\text{V}$	$T_j = 25^\circ\text{C}$		250	μA
			$T_j = 125^\circ\text{C}$		500	
I_F	DC Forward Current	$T_c = 80^\circ\text{C}$		100		A
V_F	Diode Forward Voltage	$I_F = 100\text{A}$		1		V
		$I_F = 200\text{A}$		1.4		
		$I_F = 100\text{A}$	$T_j = 125^\circ\text{C}$		0.9	
t_{rr}	Reverse Recovery Time	$I_F = 100\text{A}$ $V_R = 133\text{V}$ $di/dt = 200\text{A}/\mu\text{s}$	$T_j = 25^\circ\text{C}$		60	ns
			$T_j = 125^\circ\text{C}$		110	
Q_{rr}	Reverse Recovery Charge	$I_F = 100\text{A}$ $V_R = 133\text{V}$ $di/dt = 200\text{A}/\mu\text{s}$	$T_j = 25^\circ\text{C}$		200	nC
			$T_j = 125^\circ\text{C}$		840	

Thermal and package characteristics

Symbol	Characteristic	Min	Typ	Max	Unit	
R _{thJC}	Junction to Case Thermal Resistance	Transistor		0.32	°C/W	
		Diode		0.55		
V _{ISOL}	RMS Isolation Voltage, any terminal to case t = 1 min, I _{isol} < 1mA, 50/60Hz	2500			V	
T _J	Operating junction temperature range	-40		150	°C	
T _{STG}	Storage Temperature Range	-40		125		
T _C	Operating Case Temperature	-40		100		
Torque	Mounting torque	To Heatsink	M5	2.5	4.7	N.m
Wt	Package Weight				160	g

Temperature sensor NTC (see application note APT0406 on www.microsemi.com for more information).

Symbol	Characteristic	Min	Typ	Max	Unit
R ₂₅	Resistance @ 25°C		50		kΩ
B _{25/85}	T ₂₅ = 298.15 K		3952		K

$$R_T = \frac{R_{25}}{\exp \left[B_{25/85} \left(\frac{1}{T_{25}} - \frac{1}{T} \right) \right]}$$

T: Thermistor temperature
 R_T: Thermistor value at T

SP4 Package outline (dimensions in mm)

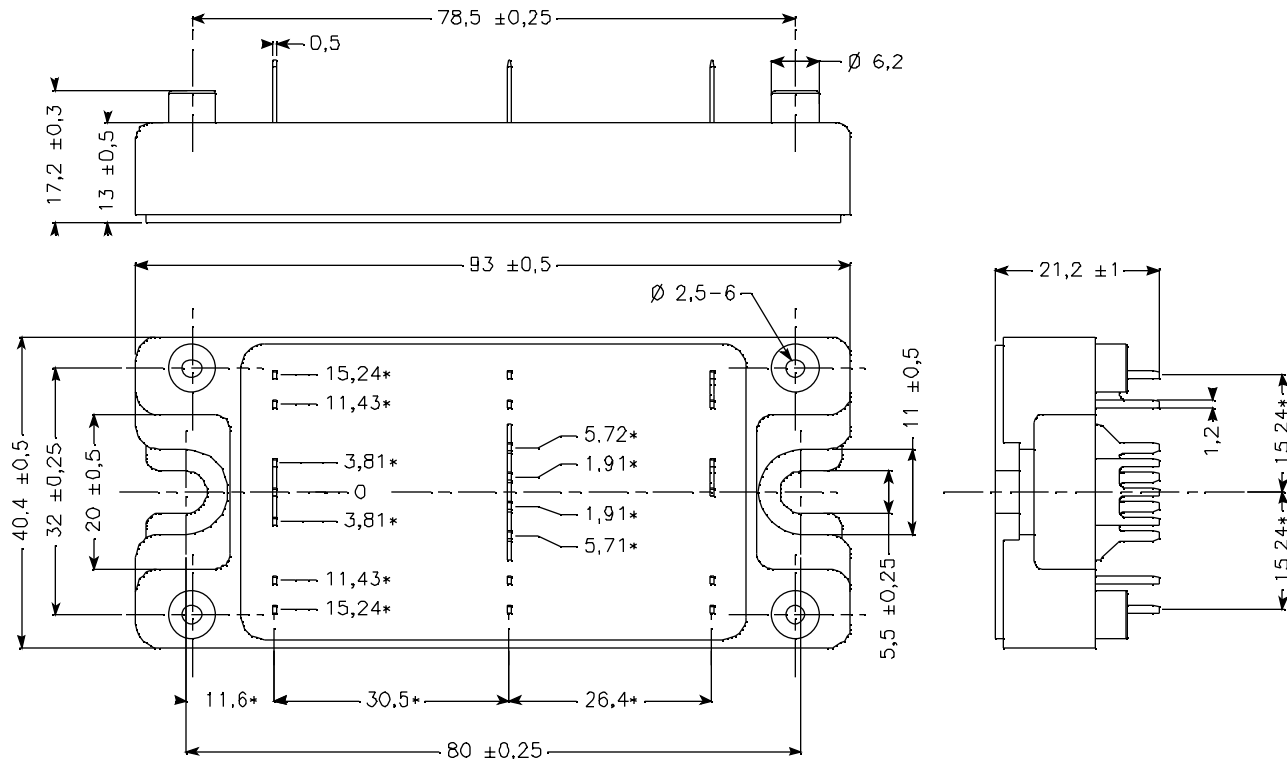

ALL DIMENSIONS MARKED "*" ARE TOLERENCED AS: $\pm 0,1$

See application note APT0501 - Mounting Instructions for SP4 Power Modules on www.microsemi.com

Typical Performance Curve

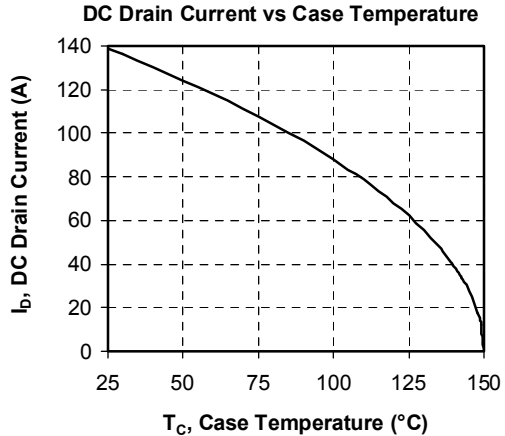
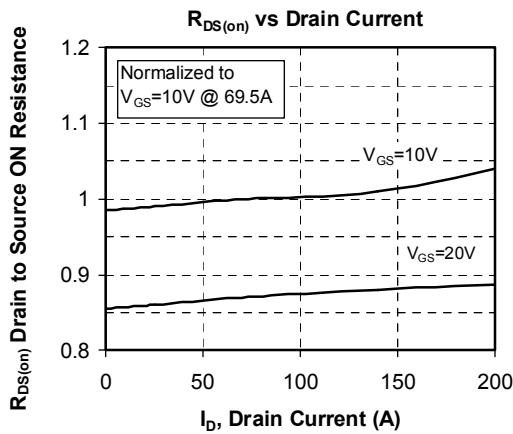
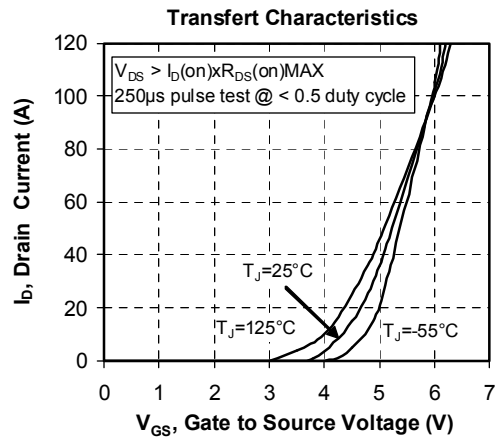
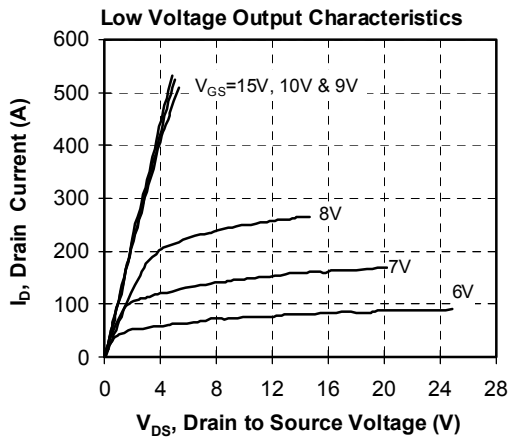
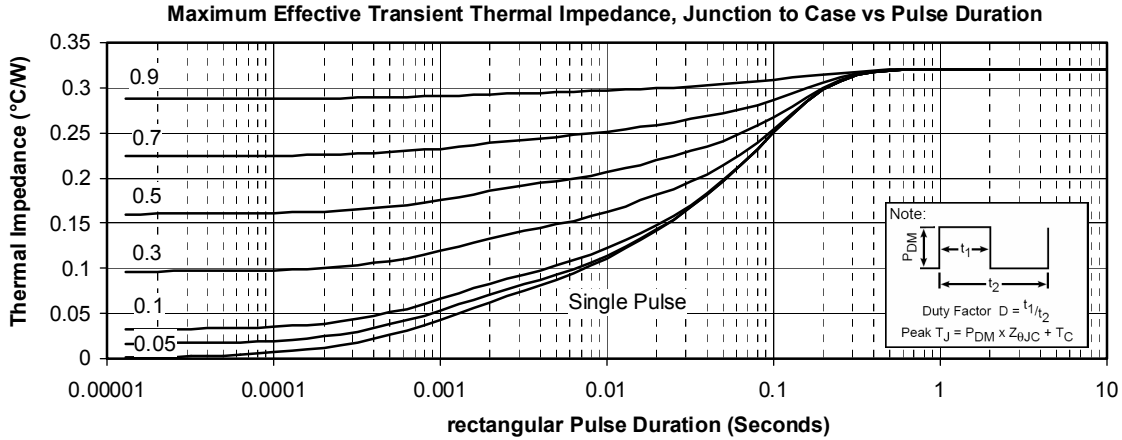

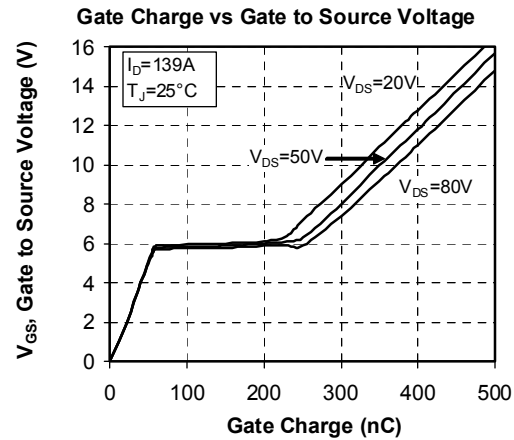
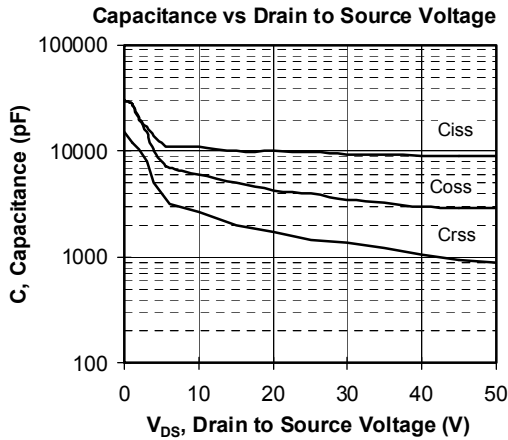
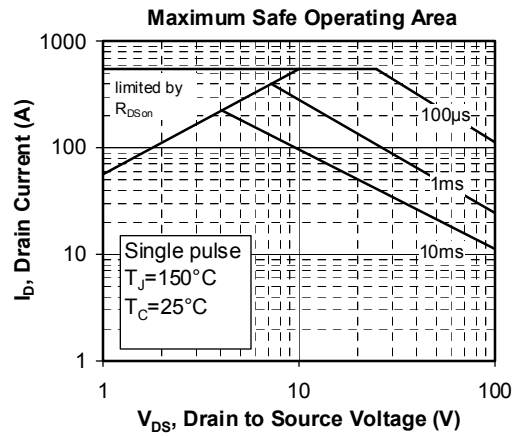
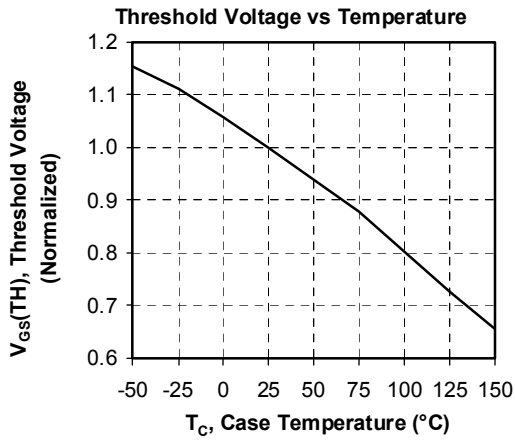
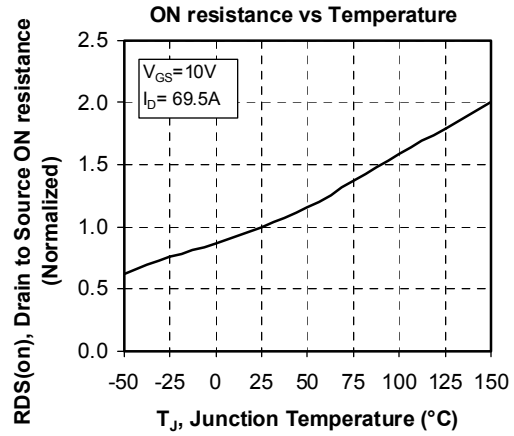

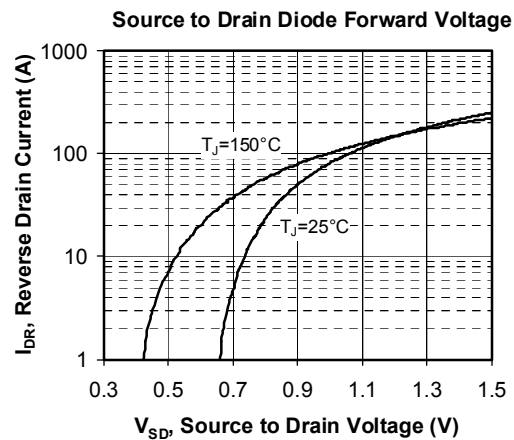
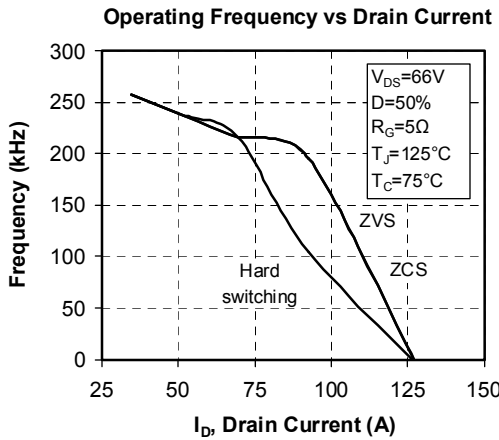
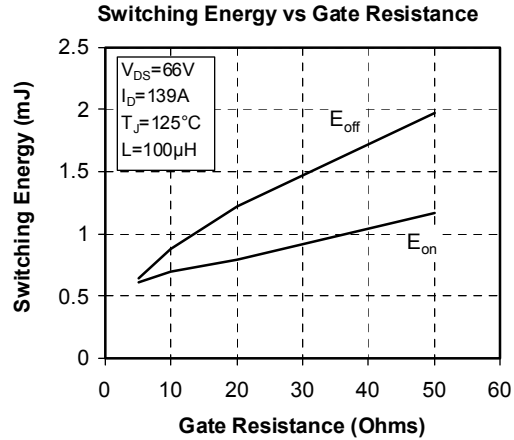
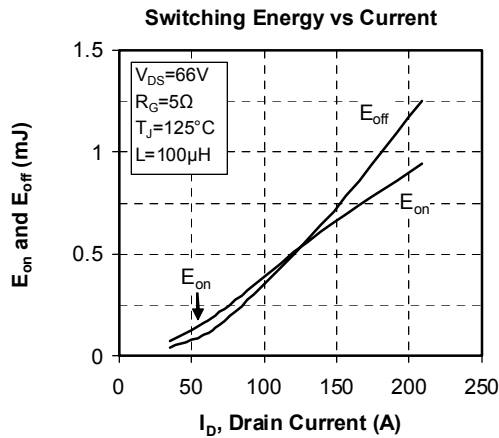
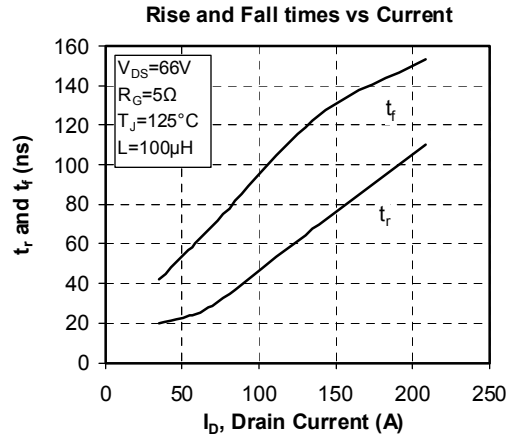
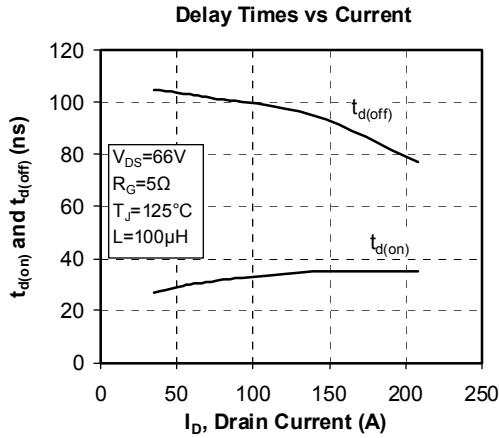

Microsemi reserves the right to change, without notice, the specifications and information contained herein

Microsemi's products are covered by one or more of U.S. patents 4,895,810 5,045,903 5,089,434 5,182,234 5,019,522 5,262,336 6,503,786 5,256,583 4,748,103 5,283,202 5,231,474 5,434,095 5,528,058 and foreign patents. U.S. and Foreign patents pending. All Rights Reserved.